

PERFORMANCE SPECIFICATIONS:

Part Number: RPR820-75
 Frequency: DC-2.0GHz

75 Watts (2KW Peak)

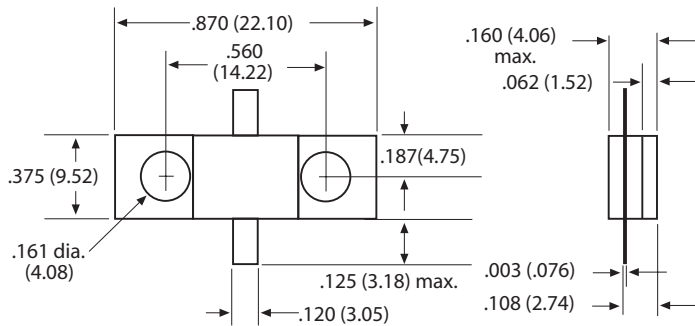

PERFORMANCE SPECIFICATIONS:

Part Number: RPR875-75
 Frequency: DC-2.0GHz

75 Watts (4KW Peak)